

NINJA®

NJ600 Series
OWNER'S GUIDE

Professional Blender

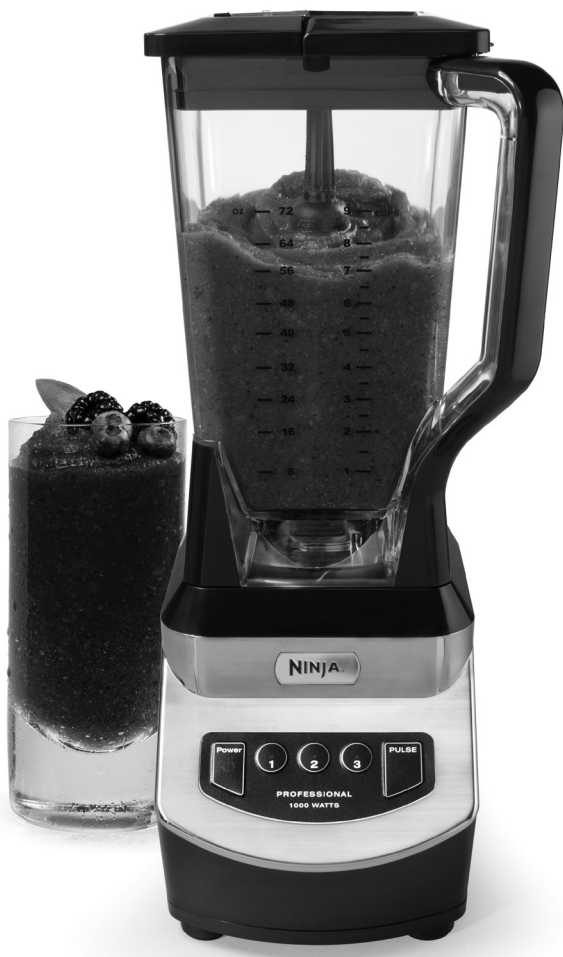

www.ninjakitchen.com
1 877 646-5288

IMPORTANT SAFETY INSTRUCTIONS

For Household Use Only

WHEN USING ELECTRICAL APPLIANCES, BASIC SAFETY PRECAUTIONS SHOULD ALWAYS BE FOLLOWED, INCLUDING THE FOLLOWING:

READ ALL INSTRUCTIONS BEFORE USING YOUR NINJA® PROFESSIONAL BLENDER.

POLARIZED PLUG

⚠ WARNING: To reduce the risk of electric shock, this appliance has a polarized plug (one blade is wider than the other). This plug will fit into a polarized outlet only one way. If the plug does not fit fully into the outlet, reverse the plug. If it still does not fit, contact a qualified electrician to install the proper outlet. DO NOT modify the plug in any way.

⚠ WARNING: Extension cords are not recommended for use with this product.

THIS BOOK COVERS MODEL NUMBERS:

NJ600
NJ600RC

TECHNICAL SPECIFICATIONS

Voltage: 120V., 60Hz.
Power: 1000 Watts

Pitcher Capacity: 72 oz. (9 cups, 2.1 L)
MAX Liquid Capacity: 64 oz. (8 cups, 1.9 L)

⚠ WARNING:

TO REDUCE THE RISK OF FIRE, ELECTRIC SHOCK OR INJURY:

- 1 **⚠ WARNING:** Remove utensils prior to processing. Failure to remove may cause the jar to be damaged or to shatter which may cause personal injury.
- 2 **⚠ WARNING:** The Stacked Blade Assembly is sharp, not locked in place and removable, handle with care. When handling the Stacked Blade Assembly, always hold by the shaft. Failure to do so will result in a risk of laceration.
- 3 **⚠ WARNING:** Stacked Blade Assembly is sharp and not locked in place. If using the pour spout, ensure the lid is fully locked onto the pitcher. If pouring with the lid removed, carefully remove the Stacked Blade Assembly first, holding it by the shaft. Failure to do so will result in a risk of laceration.
- 4 **⚠ CAUTION:** Do not blend hot liquids, doing so may cause excessive pressure build-up, resulting in risk of the user being burned.
- 5 To protect against electrical shock, do not submerge the appliance or allow the power cord to come into contact with water or any other liquid.
- 6 **DO NOT** allow young children to operate the appliance or use as a toy. Close supervision is necessary when any appliance is used near children.
- 7 Never leave an appliance unattended when in use.



- 8 Turn the appliance Off and remove the power cord from the electrical outlet when not in use, before assembling or disassembling parts and before cleaning. To unplug, grasp the plug and pull from the electrical outlet. Never pull from the power cord.
- 9 Appliance accessories are not intended to be used in the microwave as it may result in damage to the accessories.
- 10 **DO NOT** abuse the power cord. Never carry the appliance by the power cord or yank it to disconnect from electrical outlet; instead grasp the plug and pull to disconnect.
- 11 **DO NOT** operate any appliance with a damaged cord or plug, or after the appliance malfunctions, has been dropped or damaged in any manner. This appliance has no serviceable parts. Return the appliance to SharkNinja Operating LLC for examination, repair or adjustment.
- 12 **DO NOT** let the power cord hang over the edge of table or counter or touch hot surfaces such as the stove.
- 13 Always use the appliance on a dry, level surface.
- 14 Keep hands, hair, clothing, as well as utensils out of container while processing to reduce the risk of severe injury to persons or damage to the appliance. A scraper may be used but only when the appliance is not running.
- 15 Avoid contact with moving parts.
- 16 **DO NOT attempt to sharpen blades.**
- 17 **DO NOT** use the appliance if blade assembly is bent or damaged.
- 18 To reduce risk of injury, never place the blade assembly on base without pitcher properly attached.
- 19 **DO NOT** operate this appliance on or near any hot surfaces (such as gas or electric burner or in a heated oven).
- 20 The use of attachments or accessories including canning jars, not recommended by the manufacturer may result in fire, electric shock or personal injury.
- 21 **DO NOT** remove the pitcher from the motor base while the appliance is in operation.
- 22 To reduce the risk of injury, **NEVER** operate the appliance without the lid in place; **DO NOT** try to defeat the interlock mechanism; make sure that the attachment is properly installed before operating the appliance.
- 23 **DO NOT** expose the pitcher to extreme temperature changes.
- 24 **DO NOT** overfill. Never fill past the “Max” line.
- 25 **DO NOT** operate the appliance empty.
- 26 To reduce the risk of burns, always allow the appliance to cool before taking off parts and before cleaning.
- 27 In the event that the unit overheats, a thermal switch will become activated and shut off the motor. To reset the appliance, unplug the appliance and let it cool down for approximately 15 minutes before using again.
- 28 **THIS PRODUCT IS INTENDED FOR HOUSEHOLD USE ONLY.** Do not use this appliance for anything other than its intended use. Do not use outdoors.
- 29 The maximum rating is based on the Stacked Blade Assembly (pitcher) that drives the greatest power and other recommended attachments may draw significantly less power or current.

SAVE THESE INSTRUCTIONS

Contents

**Thank you for
purchasing
the Ninja®
Professional
Blender.**

Getting Started	4
Before First Use	5
Assembly and Use of the Pitcher	6
Care & Maintenance	8
Replacement Parts	8
Blending Chart	9
Troubleshooting Guide	9
Warranty	10

The Ninja® Professional Blender is a high powered kitchen tool that is perfect for ice crushing, blending, pureeing and controlled processing. Create all of your favorite recipes fast and easy with just one touch of a button. For best results, be sure to carefully read all the instructions contained in the manual before using this appliance.

FEATURES:

- Easy lock lid with built-in pour spout
- Total Crushing® Technology
- Extra Large 72 oz. pitcher (MAX Liquid Capacity: 64 oz.) - BPA Free
- Easy to clean electronic control panel
- Cord storage
- Non Slip Bottom



Getting Started

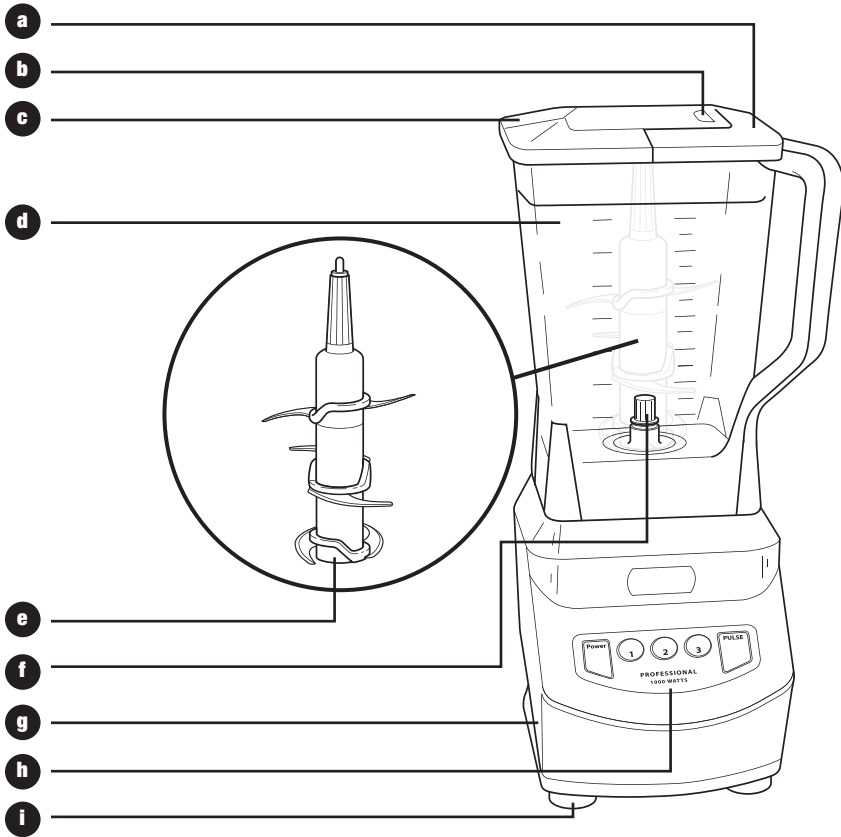

a Lid with Locking Handle

b Locking Handle Release Button

c Pouring Spout with Cap

d Pitcher

e Stacked Blade Assembly

f Gear Shaft

g Motor Base

h Control Panel

i Non Slip Bottom

j Power Cord (not shown)

k Cord Storage (in back) (not shown)

PLEASE KEEP THESE IMPORTANT SAFEGUARDS IN MIND WHEN USING THE APPLIANCE:

IMPORTANT: Make sure that the motor base is plugged in for use.

IMPORTANT: Never add ingredients into the container before placing the Blade Assembly in first.

IMPORTANT: DO NOT attempt to operate the appliance without the lid on.

IMPORTANT: Never run the appliance empty.

IMPORTANT: Appliance accessories are not intended to be used in the microwave as it may result in damage to the accessories.

⚠ WARNING: Stacked Blade Assembly is sharp and not locked in place. If using the pour spout, ensure the lid is fully locked onto the pitcher. Failure to do so will result in a risk of laceration.

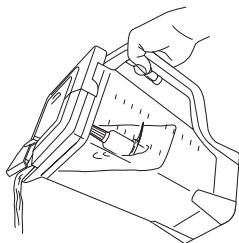

⚠ WARNING: Stacked Blade Assembly is sharp and not locked in place. If pouring with the lid removed, carefully remove the Stacked Blade Assembly first, holding it by the shaft. Failure to do so will result in a risk of laceration.

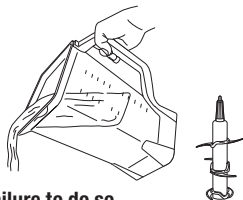

⚠ CAUTION: Do not immerse the motor base into water or any other liquid.

- 1 Remove all packaging material and labels from the appliance. Separate/remove all parts from each other.
- 2 Wash the lid, pitcher and Stacked Blade Assembly in warm, soapy water. When washing the Stacked Blade Assembly, use a dishwashing utensil with a handle to avoid direct hand contact with blades.

⚠ WARNING: Handle the Stacked Blade Assembly with care when washing, as the blades are very sharp.

- 3 Handle blade assemblies with care to avoid contact with sharp edges. Rinse and air dry thoroughly.
- 4 The pitcher, lid and Stacked Blade Assembly are all dishwasher safe. It is recommended that the lid and Stacked Blade Assembly go on the top rack. Ensure that the Stacked Blade Assembly is removed from the pitcher before placing in the dishwasher.
- 5 The motor base can be wiped clean with a damp cloth.

Assembly and Use of the Pitcher

- ⚠ **WARNING:** Handle the Stacked Blade Assembly with care, as the blades are sharp.
 - ⚠ **WARNING:** Remove utensils prior to processing. Failure to remove may cause the pitcher to be damaged or to shatter, which may cause personal injury.
 - ⚠ **WARNING:** Never leave the appliance unattended while in use.
 - ⚠ **CAUTION:** Do not blend hot liquids, doing so may cause excessive pressure buildup, resulting in risk of the user being burned.
- IMPORTANT:** Make sure that the motor base is plugged in for use.

ASSEMBLY

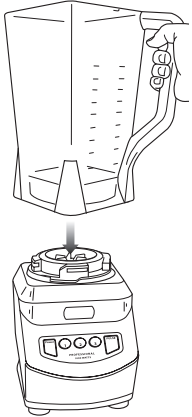

Fig. 1

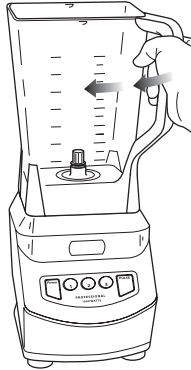

Fig. 2

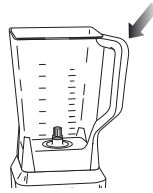

Fig. 3a

OR



Fig. 3b

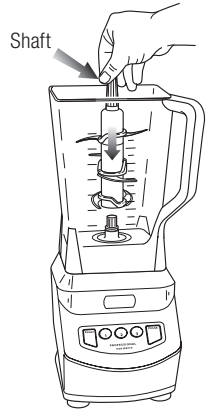
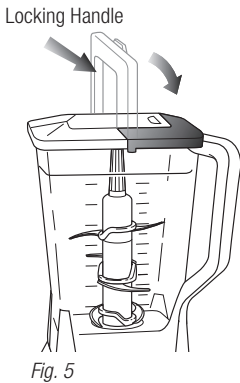

Fig. 4

- 1 Review warning and caution statements above before proceeding to number 2.
- 2 Place the motor base on a clean, dry, level surface.
- 3 Lower the pitcher onto the motor base. **(Fig. 1)**
- 4 Rotate the pitcher to the left as far as it will go. As the pitcher rotates, it will lower and the safety tabs on the bottom of the pitcher will slide under the safety tabs on the top of the motor base. **(Fig. 2)**
- 5 The pitcher can be placed on the motor base two ways; the handle can be on the front right corner or the front left corner. **(Fig. 3a, Fig. 3b)**
- 6 Holding the Stacked Blade Assembly by the shaft, place it onto the gear shaft inside the pitcher. **(Fig. 4)** Ensure that the Stacked Blade Assembly fits around the gear shaft and that the blade shaft is standing straight.
NOTE: The Stacked Blade Assembly will fit loosely on the drive gear.
- 7 Add the ingredients to the pitcher. Make sure your total of ingredients don't go higher than the highest measured marking line on the side of the pitcher.
NOTE: When blending any kind of liquids, such as mixtures of any drinks or smoothies, do not exceed the "Max liquid" mark (64 oz.) on the pitcher
- 8 Plug the power cord into the electrical outlet.
IMPORTANT: As a safety feature, the motor will not work if the pitcher and lid are not installed correctly. When the pitcher and lid are installed properly, the ready light will be solid green, indicating that the blender is ready for use.

Assembly and Use of the Pitcher - cont.

USE



REMOVAL

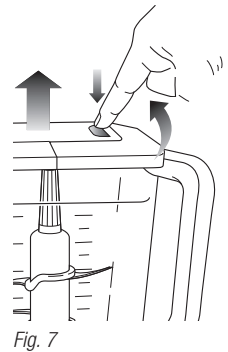
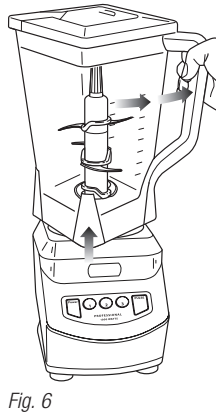

- 9 Review warning and caution statements on page 6 before proceeding.
 - 10 Holding the lid by the handle in the upright position, place it on top of the pitcher aligning the arrow (▼) located on the lid with the arrow (▲) located on the bowl's handle. (Fig. 5)
 - 11 Select the speed according to your blending requirements*:
 - Use the speed 1 button for processing and mixing.
 - Use the speed 2 button for blending and ice crushing.
 - Use the speed 3 button for pureeing and liquefying.
 - Use the pulse button for controlled chopping and processing.* See Blending Chart.
- NOTE:** If you need to add additional ingredients while the blender is processing, open the pouring spout cap and pour the ingredients in through the opening.
- 12 Press power button (⏻) or the same speed button a second time to stop the Stacked Blade Assembly or press a different button to change the speed.

- 13 To remove the pitcher, press the power button (⏻) to turn the appliance 'Off'. Wait for the Stacked Blade Assembly to stop moving before removing. (Fig. 6)

⚠ WARNING: Never insert your hands in the pitcher as the Stacked Blade Assembly is sharp. Always use a spatula to dislodge food that has stuck to the sides of the pitcher.

- 14 Open the pour spout cap and use the spout to empty liquid contents.
- 15 For thicker consistencies, first remove the lid by pressing the release button and pulling the lid handle up to a 90 degree angle to lift lid off the pitcher. Then, carefully remove the Stacked Blade Assembly by the top of the shaft. Place Stacked Blade Assembly away from the work area to avoid accidental contact. Finally, empty contents from the pitcher. (Fig. 7)
- 16 Make sure that the unit is unplugged when not in use.

Care & Maintenance

HOW TO CLEAN

- ⚠ CAUTION: Make sure that the motor base is unplugged from the power source before inserting or removing any Stacked Blade Assembly and before cleaning.**
- ⚠ CAUTION: DO NOT immerse the motor base into water or any other liquid.**
- 1 Separate/remove all parts from each other.
- 2 **Hand Washing:** Wash the container, lid and blade assembly in warm, soapy water. When washing the blade assembly, use a dish-washing utensil with a handle to avoid direct hand contact with blades. Handle blade assembly with care to avoid contact with sharp edges. Rinse and air dry thoroughly.
Dishwasher: The container, lid and blade assembly are all dishwasher safe. The lid and blade assembly is topshelf dishwasher safe. Ensure that the blade assembly is removed from the container before placing in the dishwasher.
- ⚠ WARNING: Handle the Stacked Blade Assembly with care when washing, as the blades are sharp. Contact with the blades' edges can result in laceration.**
- 3 Wipe the motor base clean with a damp cloth.
Please call customer service if any servicing needs to be performed on the appliance at 1-877-646-5288.

HOW TO STORE

- 1 Store the Ninja® Professional Blender upright with the Stacked Blade Assembly inside the pitcher with the lid secured on top. Do not place anything on top. Tuck power cord in cord storage compartment in the back of the unit.

RESETTING THE MOTOR THERMOSTAT

The Ninja® Professional Blender features a unique safety system which prevents damage to the unit's motor and drive system should you inadvertently overload your appliance.

If the appliance is being overloaded, the motor will stop. Allow the appliance to cool for approximately 15 minutes. To reset the appliance, follow the resetting procedure below:

- 1 Unplug the appliance from the electrical outlet.
- 2 Remove and empty the container and ensure that no food is jamming the Stacked Blade Assembly.
- 3 Allow the appliance to cool for approximately 15 minutes.
- 4 Re-install the container onto the base and re-plug the appliance into the electrical outlet.
- 5 Proceed to use the appliance as before making sure not to exceed the recommended maximum capacities.

Replacement Parts

ORDERING REPLACEMENT PARTS

To order additional parts and accessories, please visit our website: www.ninjakitchen.com or feel free to contact customer service at: 1-877-646-5288.

Blending Chart

BUTTON	FUNCTION	USE
POWER 	On/Off	Always turn appliance 'Off' when not in use.
1	Processing & Mixing	Use to mix thin batters, gravies and marinades, scramble eggs, puree cooked foods and uncooked fruits and chop vegetables for dips and salsa.
2	Blending & Ice Crushing	Use to grate hard cheeses, cream soups*, beat dips, grind nuts, thorough chopping, blend sauces* and spreads. Blend mixed drinks, powdered drinks or milk shakes. Crush ice cubes for snow cones, chilled beverages or frozen slushes.
3	Pureeing & Liquefying	Use to mix smoothies, frappes, liquefy thick mixtures and blend whole fruits and vegetables.
PULSE	Controlled Processing & Bursts of Power	Use to control chopping and processing.

* When blending soups or sauces, make sure they're cooled to room temperature first - Ninja containers are not intended for hot blending.

Troubleshooting Guide

PROBLEMS	POSSIBLE REASONS & SOLUTIONS
Motor Doesn't Start or Stacked Blade Assembly doesn't Rotate.	<p>Make sure the pitcher is securely placed on motor base.</p> <p>Make sure the lid is securely on pitcher in the correct position (align arrows).</p> <p>The blender is turned 'Off'. Press the power button  to turn 'On'.</p> <p>Check that the plug is securely inserted into the electrical outlet.</p> <p>Check the fuse or circuit breaker.</p> <p>The unit has overheated or overloaded. Unplug and wait approximately 15 minutes before using again.</p>
Food is Unevenly Chopped.	Either you are chopping too much food at one time, or the pieces are not of even size and processing smaller amounts per batch.
Food is Chopped Too Fine or is Too Watery.	The food has been over processed. Use pulse button for controlled processing.
Food Collects On Lid or On the Sides of the Pitcher.	The mixture is too thick. Add more liquid.
You Cannot Achieve Snow From Solid Ice.	Do not use ice that has been sitting out or has started to melt. Use ice straight from the freezer.

ONE (1) YEAR LIMITED WARRANTY

SharkNinja Operating LLC warrants this product to be free from material defects and workmanship for a period of one (1) year from the date of purchase when utilized for normal household use, subject to the following conditions, exclusions and exceptions.

The liability of **SharkNinja Operating LLC** is limited solely to the cost of the repair or replacement of the unit at our option. This Limited Warranty does not cover normal wear of parts and does not apply to any unit that has been tampered with or used for commercial purposes. This Limited Warranty does not cover damage caused by misuse, abuse, negligent handling or damage due to faulty packaging or mishandling in transit. This Limited Warranty does not cover damage or defects caused by or resulting from damages from shipping or repairs, service or alteration to the product or any of its parts, which have been performed by a repair person not authorized by **SharkNinja Operating LLC**.

If your appliance fails to operate properly while in use under normal household conditions within the Limited Warranty period, you may return the complete appliance and accessories with proof of purchase and date, freight prepaid. For Customer Service support, call 1-877-646-5288 or visit our website www.ninjakitchen.com.

If the appliance is found by **SharkNinja Operating LLC** to be defective, in **SharkNinja Operating LLC's** sole discretion, we will repair or replace it free of charge. Proof of purchase date and a check made payable to **SharkNinja Operating LLC** in the amount of \$19.95 to cover the cost of return shipping and handling must be included.*

This Limited Warranty is extended to the original purchaser of the unit and excludes all other legal, implied and/or conventional warranties. The responsibility of **SharkNinja Operating LLC** if any, is limited to the specific obligations expressly assumed by it under the terms of this Limited Warranty. In no event is **SharkNinja Operating LLC** liable for incidental or consequential damages to anyone of any nature whatsoever. Some states do not permit the exclusion or limitation of incidental or consequential damages, so the above may not apply to you.

This Limited Warranty gives you specific legal rights, and you may also have other rights which vary from state to state or from province to province.

***IMPORTANT: Carefully pack item to avoid damage in shipping. Be sure to include proof of purchase date and to attach tag to item before packing with your name, complete address and phone number with a note giving purchase information, model number and what you believe is the problem with the item. We recommend you insure the package (as damage in shipping is not covered by your Limited Warranty). Mark the outside of your package "ATTENTION CUSTOMER SERVICE".**

PRODUCT REGISTRATION

Please visit www.ninjakitchen.com or call **1-877-646-5288** to register your new Ninja® product within ten (10) days of purchase. You will be asked to provide the store name, date of purchase and model number along with your name and address.

The registration will enable us to contact you in the unlikely event of a product safety notification. By registering you acknowledge to have read and understood the instructions for use, and warnings set forth in the accompanying instructions.



SharkNinja Operating LLC
US: Newton, MA 02459
CAN: Ville St-Laurent, QC H4S 1A7
1-877-646-5288
www.ninjakitchen.com

Ninja and Total Crushing are registered trademarks of SharkNinja Operating LLC.

Illustrations may differ from actual product. We are constantly striving to improve our products, therefore the specifications contained herein are subject to change without notice.

For SharkNinja U.S. Patent information visit www.sharkninja.com/USPatents.

© 2016 SharkNinja Operating LLC
NJ600_Series_30_E_IB_160212_2
PRINTED IN CHINA